

CIRCUS DIABOLO

DESIGNED BY JEAN-FRANÇOIS D'OR

tossB

PRODUCT INFORMATION

CIRCUS DIABOLO - C1S 5.5CM



LAMP TYPE	LED
COLOUR TEMP.	2700K
WATTAGE	6W
VOLTAGE	17.3V - 350mA
LUMEN	450
GEAR	NOT INCLUDED
CLASS	2

ORDER CODE

BLACK ANODIZED	T109DH1DZL
CHAMPAGNE ROSÉ	T109DH1DCR

CIRCUS DIABOLO - SB 5.5CM

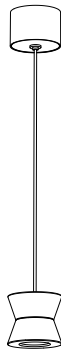

LAMP TYPE	LED
COLOUR TEMP.	2700K
WATTAGE	6W
VOLTAGE	17.3V - 350mA
LUMEN	450
GEAR	NOT INCLUDED
CLASS	1

ORDER CODE

BLACK ANODIZED	T109DH2DZL
CHAMPAGNE ROSÉ	T109DH2DCR

CIRCUS DIABOLO - SB 10CM (TRIAC)

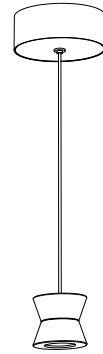

LAMP TYPE	LED
COLOUR TEMP.	2700K
WATTAGE	6W
VOLTAGE	230V
LUMEN	450
GEAR	INCLUDED (TRIAC)
CLASS	1

ORDER CODE

BLACK ANODIZED	T109DH3DZL
CHAMPAGNE ROSÉ	T109DH3DCR

CIRCUS DIABOLO - SB 10CM (DALI)

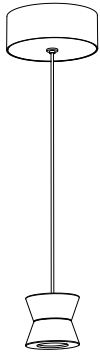

LAMP TYPE	LED
COLOUR TEMP.	2700K
WATTAGE	6W
VOLTAGE	230V
LUMEN	450
GEAR	INCLUDED (DALI)
CLASS	1

ORDER CODE

BLACK ANODIZED	T109DH3DZLD
CHAMPAGNE ROSÉ	T109DH3DCRD

DRIVERS

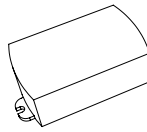

TRIAC 4-10W (8.5-28V) - 350mA

86x38xh21 ID01DP06

PUSH/1-10V 18W (2-53V) - 350mA

110x52xh22 ID01DP04

DALI 20W (3-45V) - 350mA

78x41xH22 EL20DALI

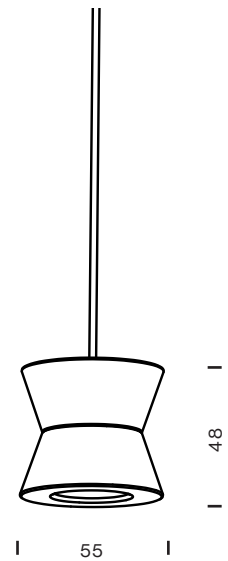

CIRCUS DIABOLO BIG - C1S 5.5CM



LAMP TYPE	LED
COLOUR TEMP.	2700K
WATTAGE	9W
VOLTAGE	18V - 500mA
LUMEN	450
GEAR	NOT INCLUDED
CLASS	2

ORDER CODE

BLACK ANODIZED	T109DH4DZL
CHAMPAGNE ROSÉ	T109DH4DCR

CIRCUS DIABOLO BIG - SB 5.5CM

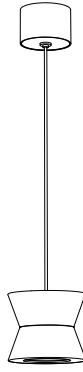

LAMP TYPE	LED
COLOUR TEMP.	2700K
WATTAGE	9W
VOLTAGE	18V - 500mA
LUMEN	450
GEAR	NOT INCLUDED
CLASS	1

ORDER CODE

BLACK ANODIZED	T109DH5DZL
CHAMPAGNE ROSÉ	T109DH5DCR

CIRCUS DIABOLO BIG - SB 10CM (TRIAC)

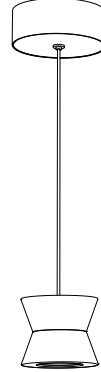

LAMP TYPE	LED
COLOUR TEMP.	2700K
WATTAGE	9W (500mA)
VOLTAGE	230V
LUMEN	450
GEAR	INCLUDED (TRIAC)
CLASS	1

ORDER CODE

BLACK ANODIZED	T109DH6DZL
CHAMPAGNE ROSÉ	T109DH6DCR

CIRCUS DIABOLO BIG - SB 10CM (DALI)

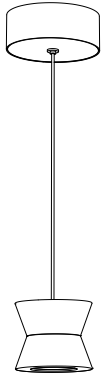

LAMP TYPE	LED
COLOUR TEMP.	2700K
WATTAGE	9W (500mA)
VOLTAGE	230V
LUMEN	450
GEAR	INCLUDED (DALI)
CLASS	1

ORDER CODE

BLACK ANODIZED	T109DH6DZLD
CHAMPAGNE ROSÉ	T109DH6DCRD

DRIVERS

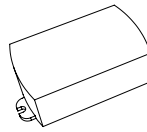

TRIAC 4-10W (8.5-28V) - 350mA

86x38xh21	ID01DP06
-----------	----------

TRIAC 3-10W (6-20V) - 500mA

86x38xh21	ID01DP13
-----------	----------

PUSH/1-10V 18W (2-53V) - 350mA

110x52xh22	ID01DP04
------------	----------

DALI 20W (3-45V) - 500mA

78x41xH22	EL20DALI
-----------	----------

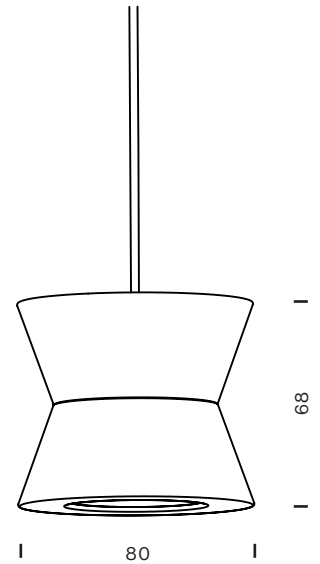

tossB

TOSSB.COM
CREATORS OF LIGHTING UNITS